

Galaxy Booklet Staple Booklet Machine Manual

galaxy
PRINT FINISHING

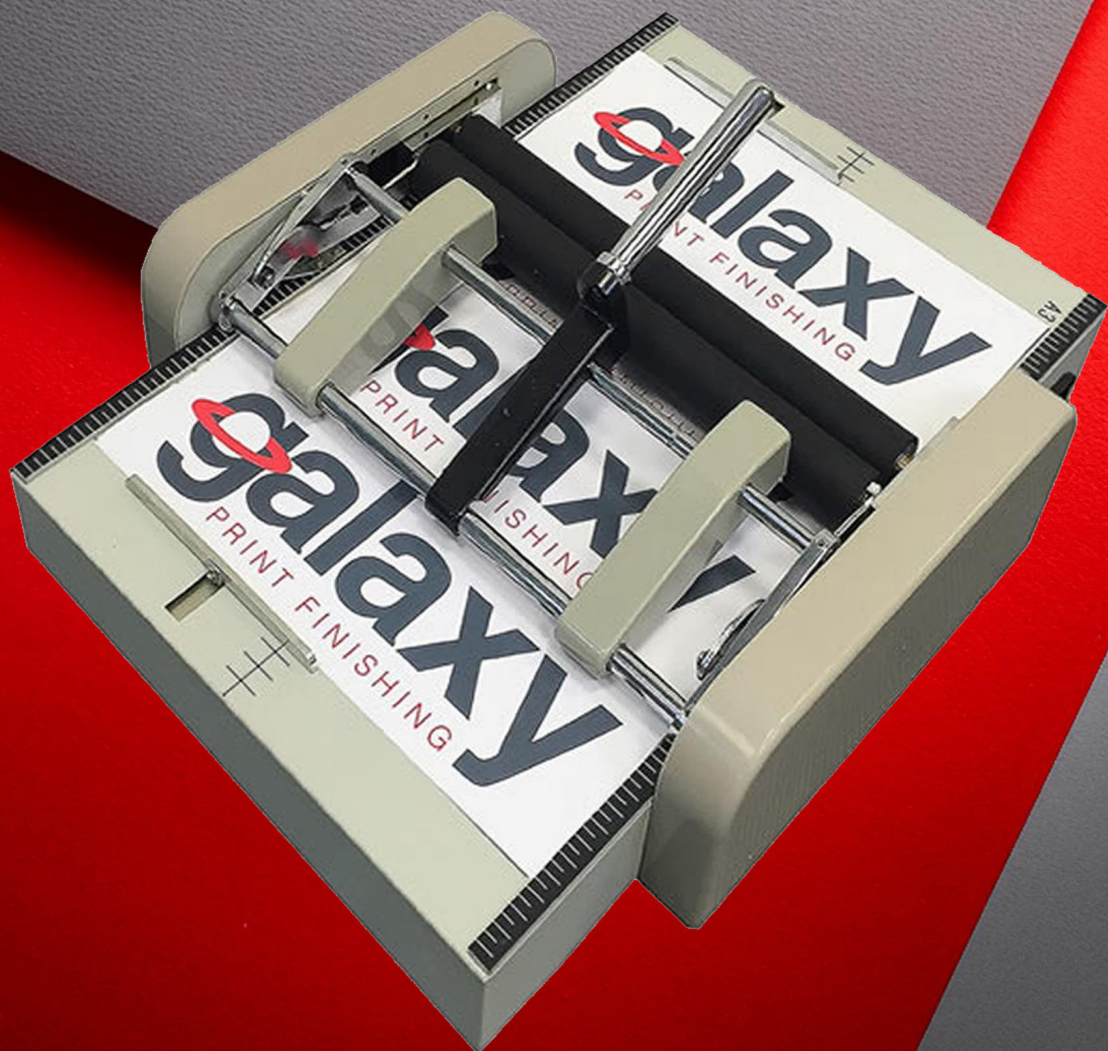

Introduction:

Welcome to Galaxy Print Finishing, your premier destination for cutting-edge print finishing solutions. With our wide range of top-quality machines and supplies, we are committed to helping you elevate the quality and professionalism of your printed materials.



At Galaxy Print Finishing, we understand the importance of flawless finishing touches, and we strive to provide you with innovative products that deliver exceptional results.

The Galaxy Bookit Booklet Maker is a user-friendly, entry-level folder and stapler that creates half-folded booklets. Its compact design, affordable price, and ease of use make it an excellent choice for small businesses, hobby clubs, schools, and churches. We hope you enjoy using your new machine and that it brings you many hours of saved labor and added convenience.

To get the most out of your Galaxy Bookit Booklet Maker, please take a moment to read through this Operation Manual carefully before using the machine. Contents:

1. Introduction
2. Safety
3. Parts
4. Instructions
5. Maintenance
6. Trouble Shooting
7. Replacing Staple Head

Safety Instructions:

	Danger: This symbol stands for immediate danger, threatening the life and health of persons. Disregarding these instructions may cause severe damage to health and even serious injuries.
	Caution: This symbol stands for an endangering situation that may occur. Disregarding these instructions may lead to slight injuries or damage to property.
	Note: This symbol stands for notes, operational hints and other useful information. They are convenient for exploiting the machine's functional abilities.

Caution:



- Keep loose items, like hair, neckties, and necklaces, away from the machine's drive to prevent potential injury.
- Place the machine on a stable, level surface. Avoid positioning it on unstable stands or slanted floors to reduce the risk of tipping or falling.
- Use only the appropriate power supply compatible with the machine.
- Load standard paper and Galaxy Print Finishing Staples for optimal results.
-
- Keep hands away from the stapler area during binding to avoid serious injury.
- Do not touch the paper folding roller while the machine is operating, as this could cause severe injuries.
- Remove any loose, hanging clothing, such as ties, before using the machine.

Parts:

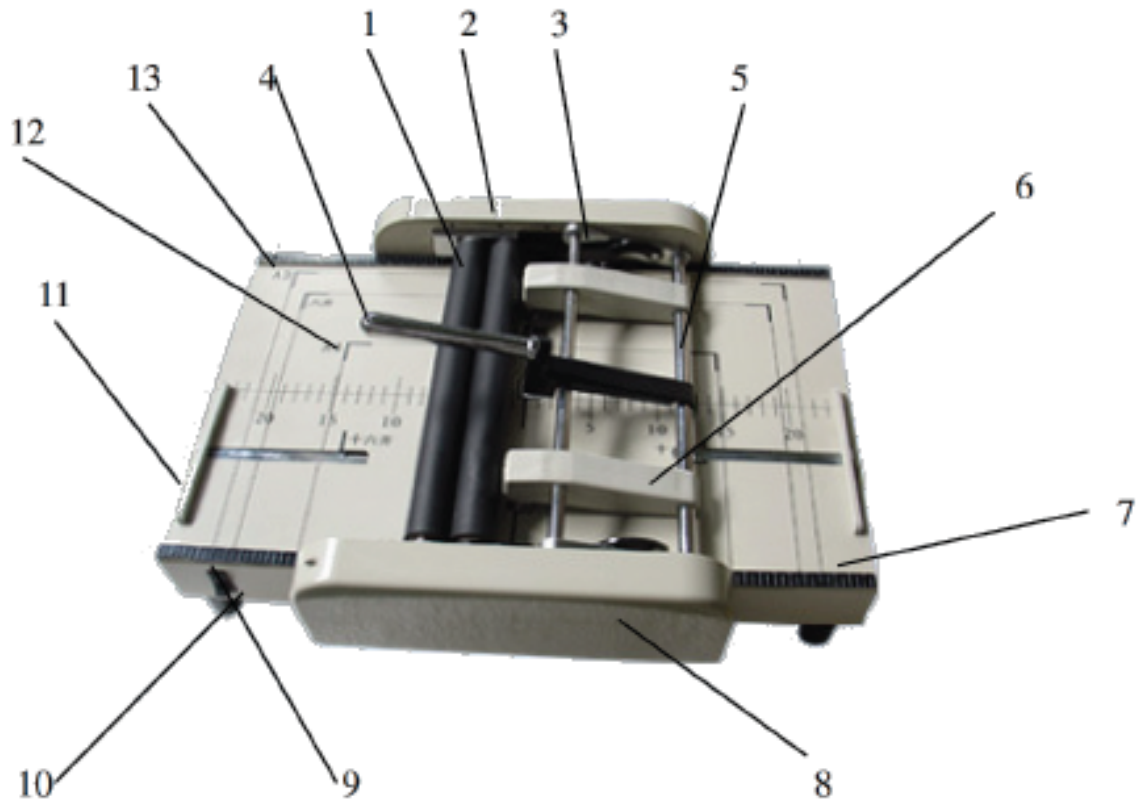

1	Paper Folding Roller	8	External Cover
2	Back Cover	9	Switch
3	Primary Axle	10	Rubber Feet
4	Handle	11	Paper Guide
5	Secondary Axle	12	Size Guide
6	Stapler	13	Ruler
7	Ruler		

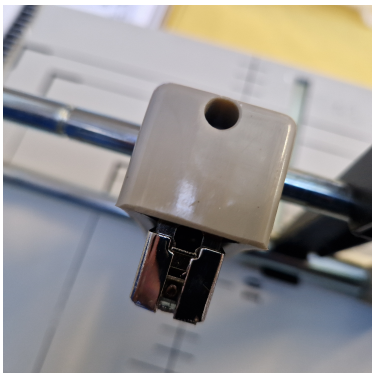

Fig 1

Operational Process:

1. Preparation Before Operation:

- Attach the handle securely.
- Load the staples into the staple head. 24/6 Staples (Product Sku 100384)
- Slide the staple heads along the bar to fit in the slots with the desired stapling positions. Use an Allen key to fix them in place if necessary. Place Allen key into the hole on The staple head case and tighten. (See fig 1)
- Confirm that all machine components are flexible and move smoothly.

2. Operation Process:

- Adjust the stapler position based on the paper size.
 - Slide in you paper under the rollers and bring front Secure the paper position by adjusting the paper guides which centralise the paper.
 - Switch the machine on by the rocker switch
 - Push down the handle to apply staples to the booklet.
 - Pull the handle back up to engage the folding mechanism; which will spin the rollers and pull up the paper to form a booklet.
 - Remove the finished booklet from the machine.
- After use, clear any remaining paper from the machine.

3. Maintenance:

Rollers are designed to feed paper smoothly through the machine. If they become slick or lose grip due to residue, paper jams and misfeeds are more likely, leading to production slowdowns. Regularly cleaning the rollers with an appropriate cleaner, like Galaxy Roller Cleaner, keeps the machine running smoothly and ensures optimal results. SKU:100586

Over time, the staple head may need replacement due to regular use and general wear. Replacement staple heads are available as consumable parts through Galaxy Print Finishing, SKU code 100872.

Specification:

Paper Size	Max: 297mm x 420mm & Min: 197mm x 273mm
Max Binding Capacity	12 pages (80gsm)
Max Folding Capacity	12pages(80gsm) or 56 pages of small volume
Voltage	AC220V 0.5A 60Hz
Power	40W
Exterior Size	L: 500mm X W: 395mm X H:220mm
Weight	13KG

Trouble Shooting:

- Booklet not coming up through the roller
 - Ensure the machine is switched on.
 - Pull the handle further back to fully engage the gear.
- Paper tears or detaches from staples
 - Pull the handle back in a quicker motion to prevent tearing.
- Paper slipping or showing stains:
 - Clean the rollers using roller cleaner (refer to maintenance section).
- Staples not working
 - Confirm that you are using the correct 24/6 staples.
 - Clear any previously used staples and load a new set.
 - Check for and clear any jams.
 - If issues persist, replace the staple heads (see maintenance section).

Replacing the Staple Heads:

Open the staple head and locate the U-shaped locking locator.

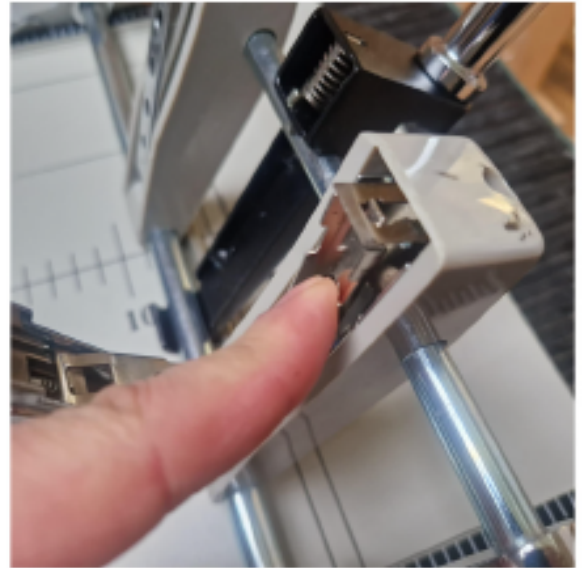

Pull the U-frame up to release the center frame.



Find the cross-head screw and mark its position for alignment. Then, remove the staple head. Insert the new staple head, aligning it with the marked line, and tighten the screw. Push the clip back under the U locator to lock it in place. Load staples into the new head and perform a test to ensure proper operation.



At Galaxy Print Finishing, we believe in delivering the highest quality products that incorporate the latest advancements in print finishing technology. We carefully curate our product offerings to ensure that you have access to the most innovative solutions in the industry. Whether you need a paper folding machine, folder inserters, staple booklet making machines, business card cutters, creasing and perforating machines, wire binding machines, or franking ink and labels, you can trust that our products are designed to meet the highest standards of performance and reliability.

Comprehensive Product Range:

At Galaxy Print Finishing, we offer a comprehensive range of print finishing solutions to address all your needs. Our product line-up includes:

- **Paper Folding Machines:** Effortlessly achieve precise and professional paper folds with our state-of-the-art machines. From single folds to complex folding patterns, our paper folding machines deliver consistent results for various paper sizes and styles.
- **Folder Inserters:** Streamline your document processing workflow with our advanced folder inserters. These machines automate the folding, insertion, and sealing of letters, invoices, and promotional materials, enhancing efficiency and accuracy.
- **Staple Booklet Making Machines:** Create stunning booklets, catalogues, and reports with ease using our staple booklet making machines. Enjoy efficient and precise stapling capabilities that ensure a polished and professional finish.
- **Business Card Cutters:** Make a lasting impression with perfectly cut and customized business cards. Our business card cutters allow you to create unique designs that reflect your brand identity and professionalism.
- **Creasing and Perforating Machines:** Add sophistication to your print materials with clean folds and precise perforations using our creasing and perforating machines. Achieve a polished look for brochures, tickets, and more with ease.
- **Wire Binding Machines:** Securely bind your documents with our user-friendly wire binding machines. From reports to presentations, our machines provide a sleek and professional finish that enhances the overall appearance.

Galaxy Print Finishing





info@galaxyprintfinishing.com
+44 (0)161 883 2722
© 2024 Galaxy Print Finishing